

Astronomische Waarneemtechnieken (Astronomical Observing Techniques)

11th Lecture: 19 November 2012

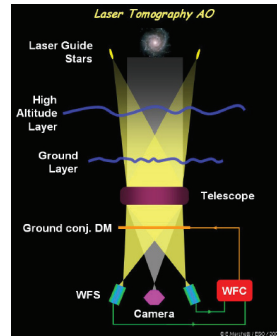
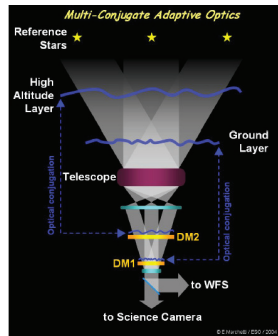
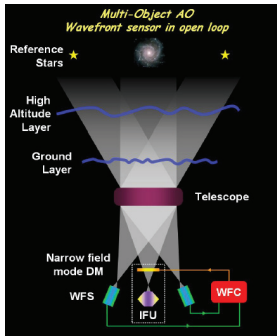

Content:

1. Atmospheric Turbulence
2. Why AO?
3. Basic Principle
4. Key Components
5. Error Terms
6. Laser Guide Stars
7. Types of AO Concepts

Based on:

"Adaptive Optics in Astronomy" (Cambridge UP) by F. Roddier (ed.),
Claire Max's lecture course on AO <http://www.ucolick.org/~max/289C/>
and ESO: http://www.eso.org/projects/aot/DSM/AO_modes.html

Reminder: Atmospheric Turbulence

Kolmogorov Turbulence

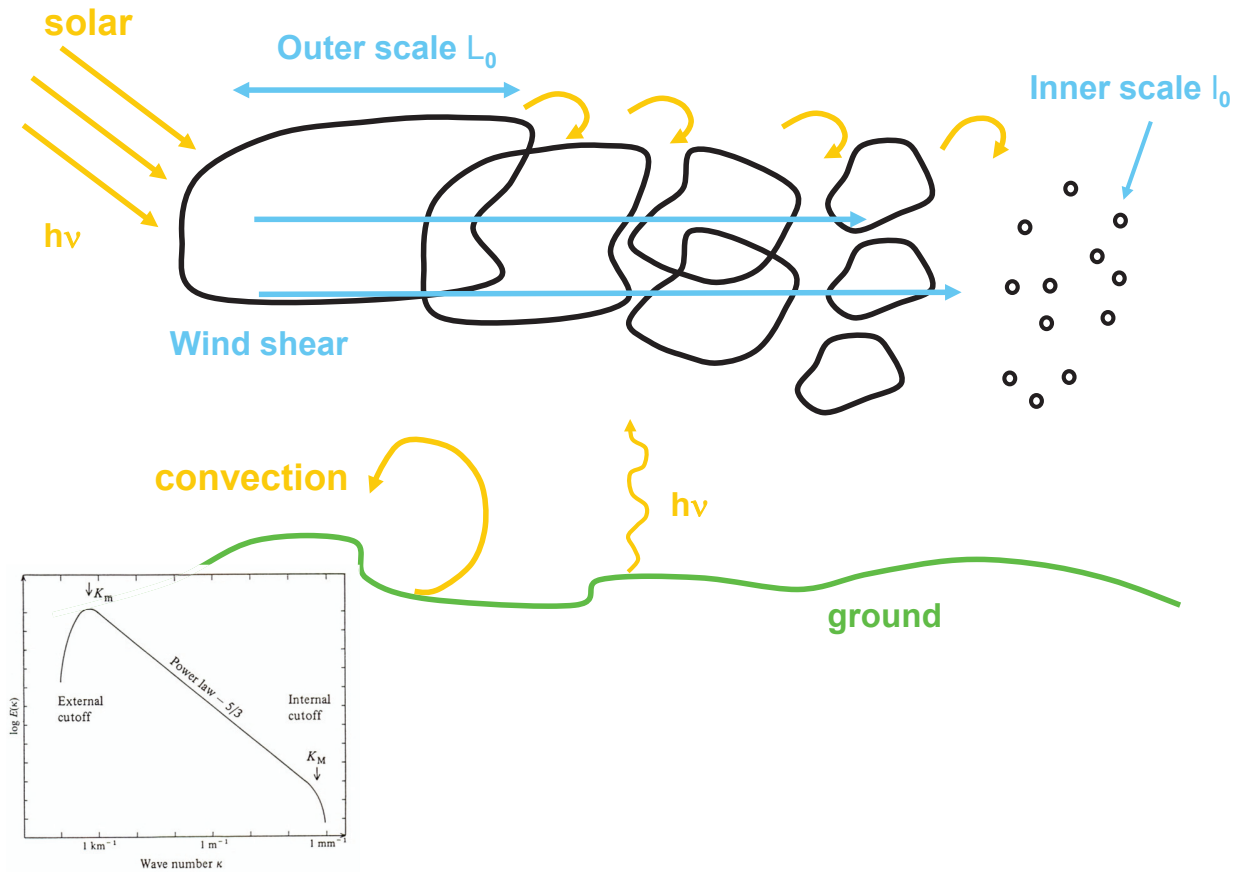

r_0 , seeing, τ_0 , θ_0

The **Fried parameter** $r_0(\lambda) = 0.185 \lambda^{6/5} \left[\int_0^\infty C_n^2(z) dz \right]^{-3/5}$ is the radius of the spatial coherence area.

It is the **average turbulent scale over which the RMS optical phase distortion is 1 radian**. Note that r_0 increases as $\lambda^{6/5}$.

$\Delta\theta = \frac{\lambda}{r_0} \sim \lambda^{-1/5}$ is called the **seeing**. At good sites r_0 ($0.5\mu\text{m}$) $\sim 10 - 30$ cm.

The **atmospheric coherence (or Greenwood delay) time** is: $\tau_0 = 0.314 \frac{r_0}{v}$. It is the maximum time delay for the RMS wavefront error to be less than 1 rad (where v is the mean propagation velocity).

The **isoplanatic angle** $\theta_0 = 0.314 \cos \zeta \frac{r_0}{h}$ is the angle over which the RMS wavefront error is smaller than 1 rad.

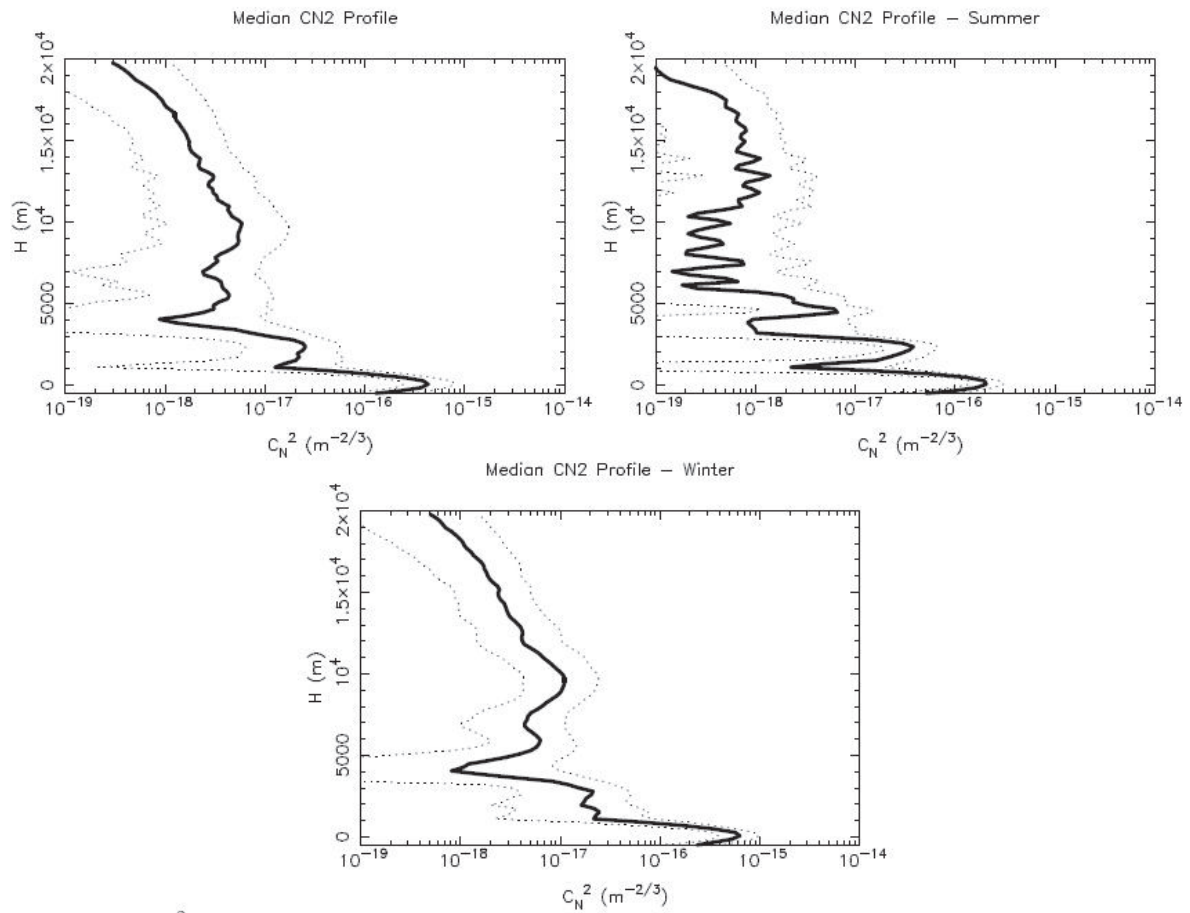
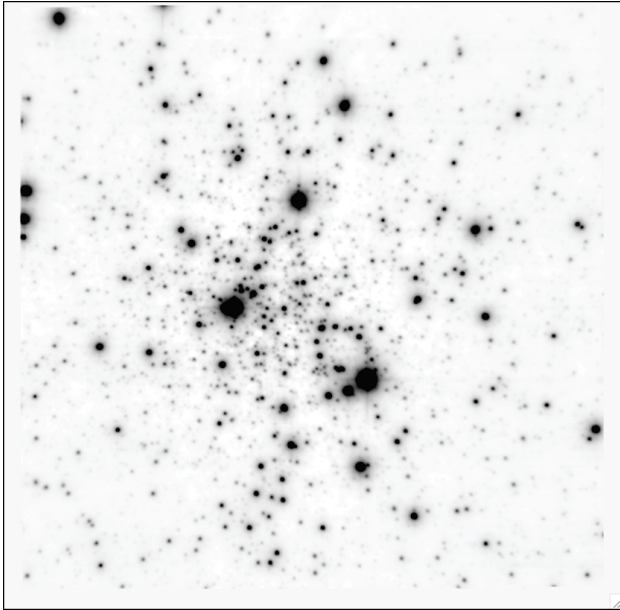

Figure 2. Median C_N^2 profile obtained with the complete sample of 43 nights, the summer [April-June] and winter [October-March] time samples. Results are obtained with the standard GS technique.

Why Adaptive Optics?

Improvement in Resolution and Sensitivity

1. Angular resolution: $\theta = \frac{\lambda}{r_0} \rightarrow \theta = \frac{\lambda}{D} \Rightarrow \text{gain} = \frac{D}{r_0}$
2. Point source sensitivity: $S/N \sim D^2 \Rightarrow \text{gain in } t_{\text{int}} \sim \frac{1}{D^4}$



PHARO LGS Ks image
500s integ., 40" FOV, 150 mas FWHM

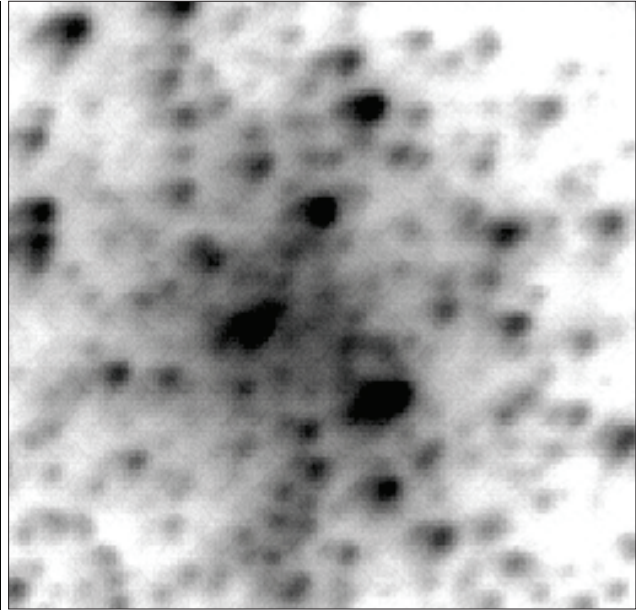

WIRO H image
Kobulnicky et al. 2005, AJ 129, 239-250

Basic AO Principle

AO Principle

1. Maximum scale of tolerated wavefront deformation is r_0
→ subdivide the telescope aperture into r_0 's
2. Measure the wavefront deformations.
3. Correct the wavefront deformations by "bending back" the patches of size r_0 .

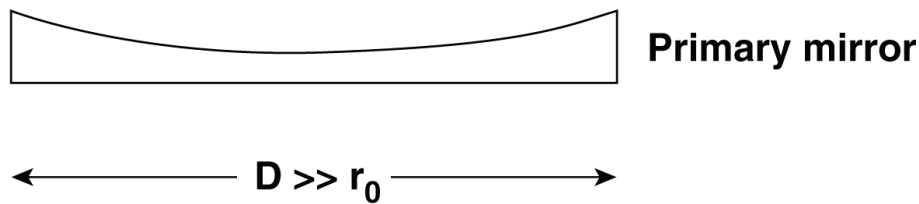

The number of subapertures is $(D/r_0)^2$ at the observing wavelength → can easily require hundreds to thousands of actuators for very large telescopes.

AO Principle (2)

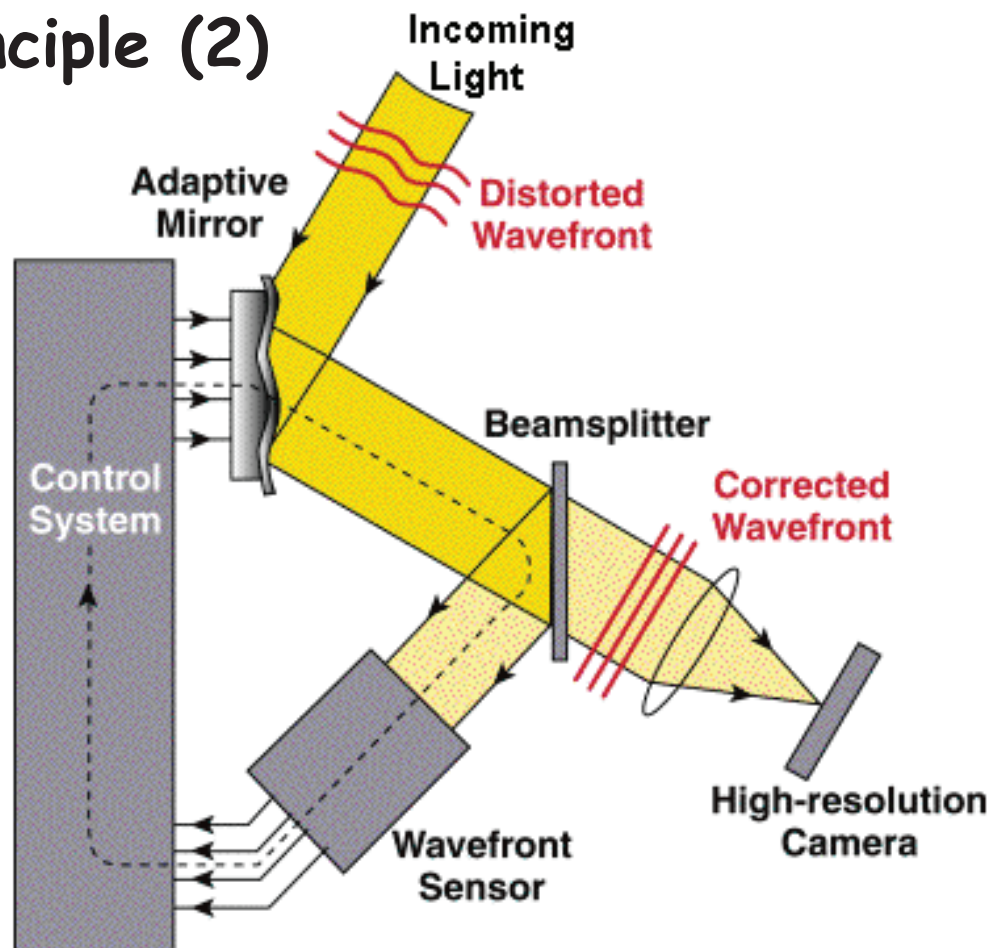

Wavefront Description: Zernike Polynomials

Expansion into a series of orthogonal terms:

$$\varphi(r,\theta) = \sum a_{m,n} Z_{m,n}(r,\theta)$$

- | | |
|--|-------------|
| $Z_{0,0} = 1$ | piston |
| $Z_{1,-1} = 2 r \sin\theta$ | } tip/tilt |
| $Z_{1,1} = 2 r \cos\theta$ | |
| $Z_{2,-2} = \sqrt{6} r^2 \sin 2\theta$ | astigmatism |
| $Z_{2,0} = \sqrt{3} (2r^2 - 1)$ | focus |
| $Z_{2,2} = \sqrt{6} r^2 \cos 2\theta$ | astigmatism |

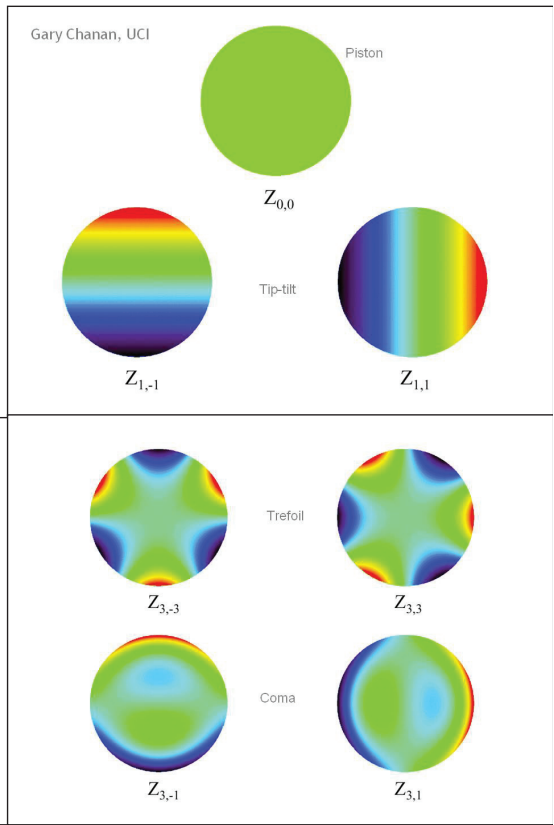

Tip-Tilt and higher order Terms (1)

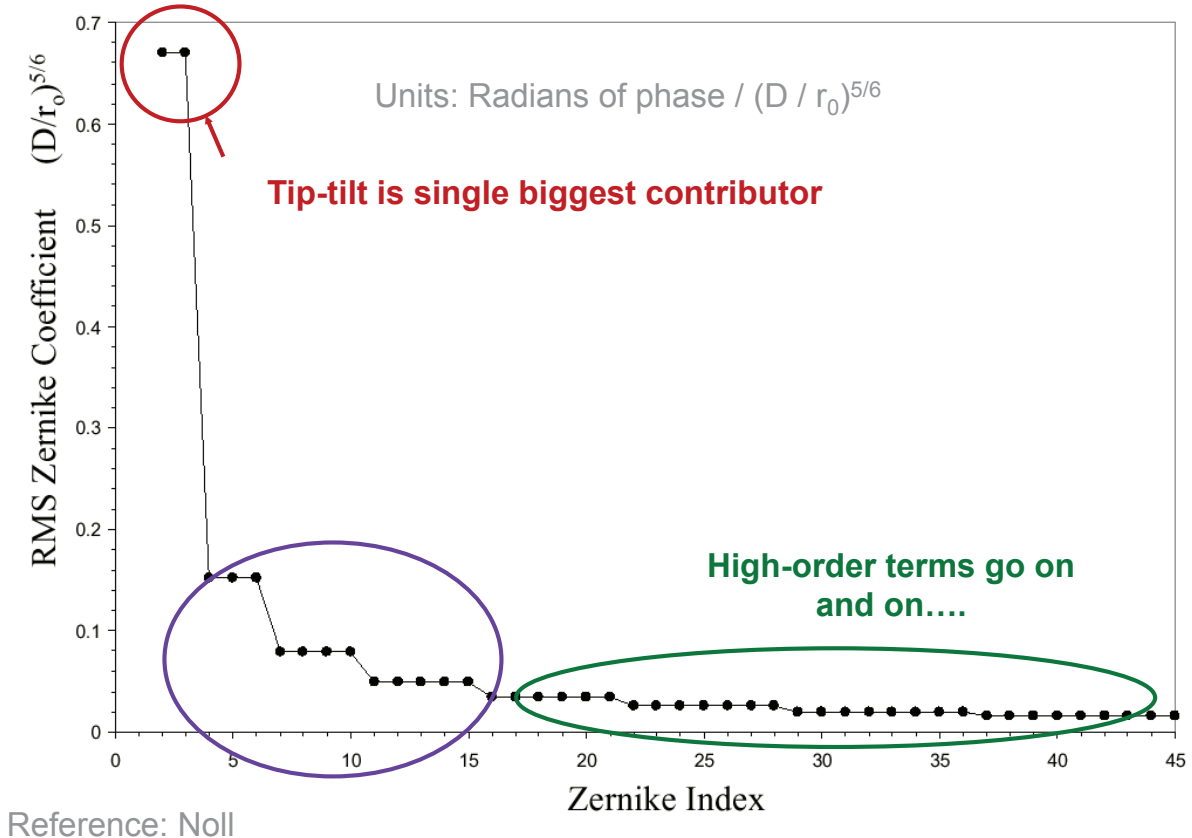

AO – Key Components

Wavefront Sensors - Shack Hartmann

Most common principle is the [Shack Hartmann](#) wavefront sensor measuring sub-aperture tilts:

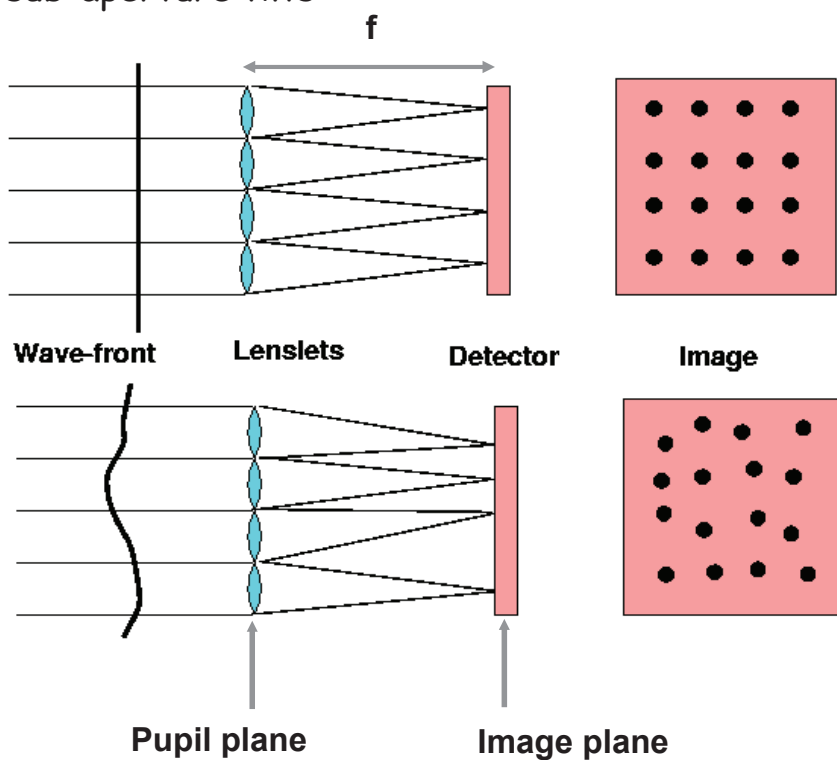

WFs: Curvature and Pyramid Sensors

Other common principles are the

curvature sensor →

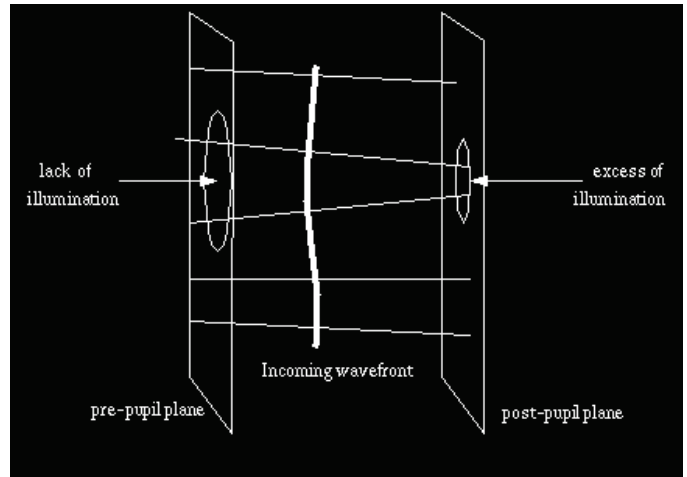

and the pyramid sensor →

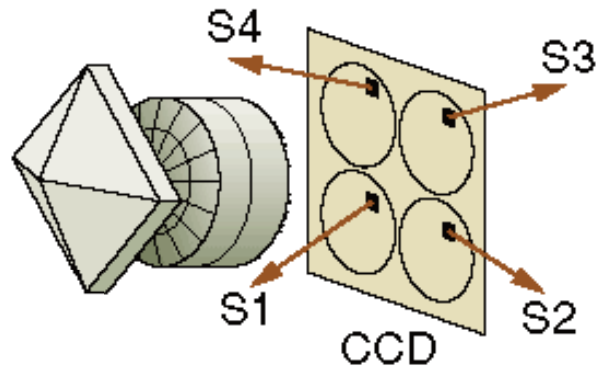

Deformable Mirrors

Basic principle: piece-wise linear fit of the mirror surface to the wavefront. r_0 sets the number of degrees of freedom.

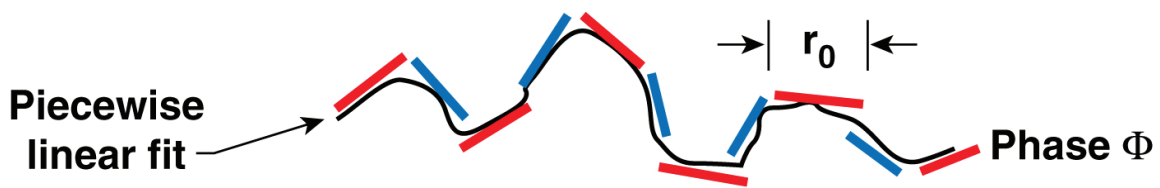

Two general types: segmented mirrors



and continuous face-sheet mirrors:

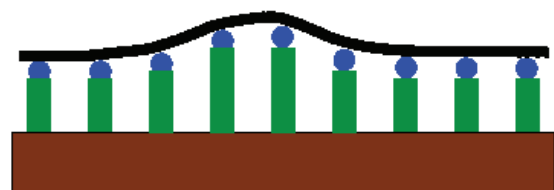

Note that the (piezo) actuator stroke is typically only a couple of micrometers → requires separate tip-tilt mirror.

Adaptive Secondary Mirrors

Concept: integrate DM into the telescope
→ adaptive secondary mirrors.

Advantages:

- no additional optical system needed → lower emission, higher throughput
- large surface → higher actuator density
- larger stroke → no tip-tilt mirror needed

...but also more difficult to build, control, and handle.

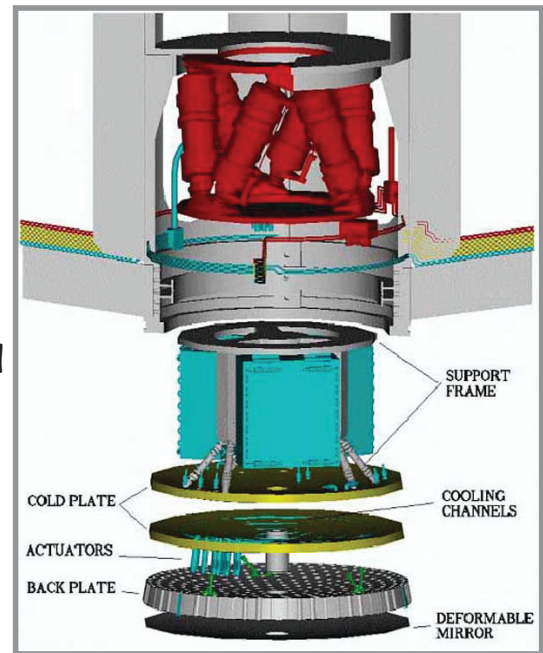
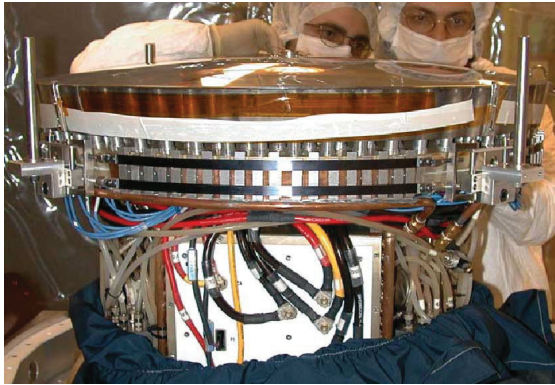

DM for MMT Upgrade

AO Correction Error Terms

Typical AO Error Terms

• **Fitting errors** from insufficient approximation of the wavefront (finite actuator spacing, influence function of actuators, etc.).

$$\sigma_{fit}^2 \approx 0.3 \left(\frac{D}{r_0} \right)^{5/3}$$

• **Temporal errors** from the time delay between measurement and correction (computing, exposure time).

$$\sigma_{temp}^2 \approx \left(\frac{t}{\tau_0} \right)^{5/3}$$

• **Measurement errors** from the WFS (S/N!)

$$\sigma_{measure}^2 \sim S / N$$

• **Calibration errors** from aberrations in the non-common path between sensing channel and imaging channel.

$$\sigma_{calibration}^2 \sim ???$$

• **Angular anisoplanatism** from sampling different lines of sight through the atmosphere.

$$\sigma_{aniso}^2 \approx \left(\frac{\theta}{\theta_0} \right)^{5/3}$$

Angular Anisoplanatism

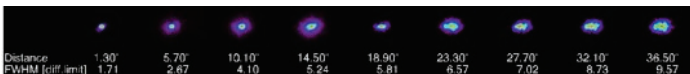

Angular anisoplanatism is a severe limitation to:

- wide-field imaging
- sky coverage (finding a guide star within the isoplanatic angle)

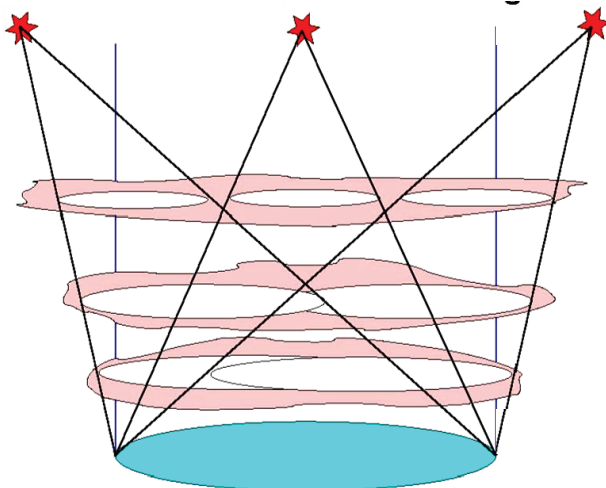

Multi-LGS allows to fight cone effect AND increase FOV

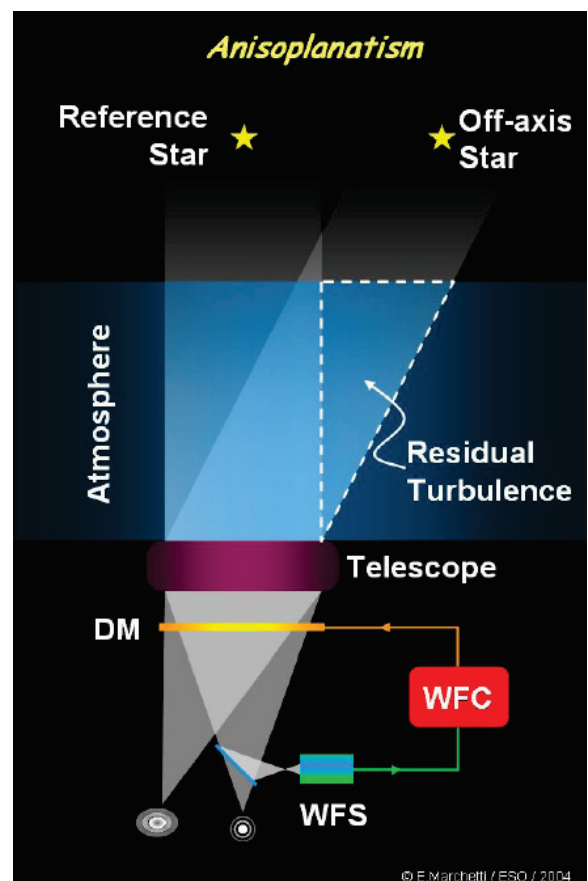

"Typical" Correction and Residuals

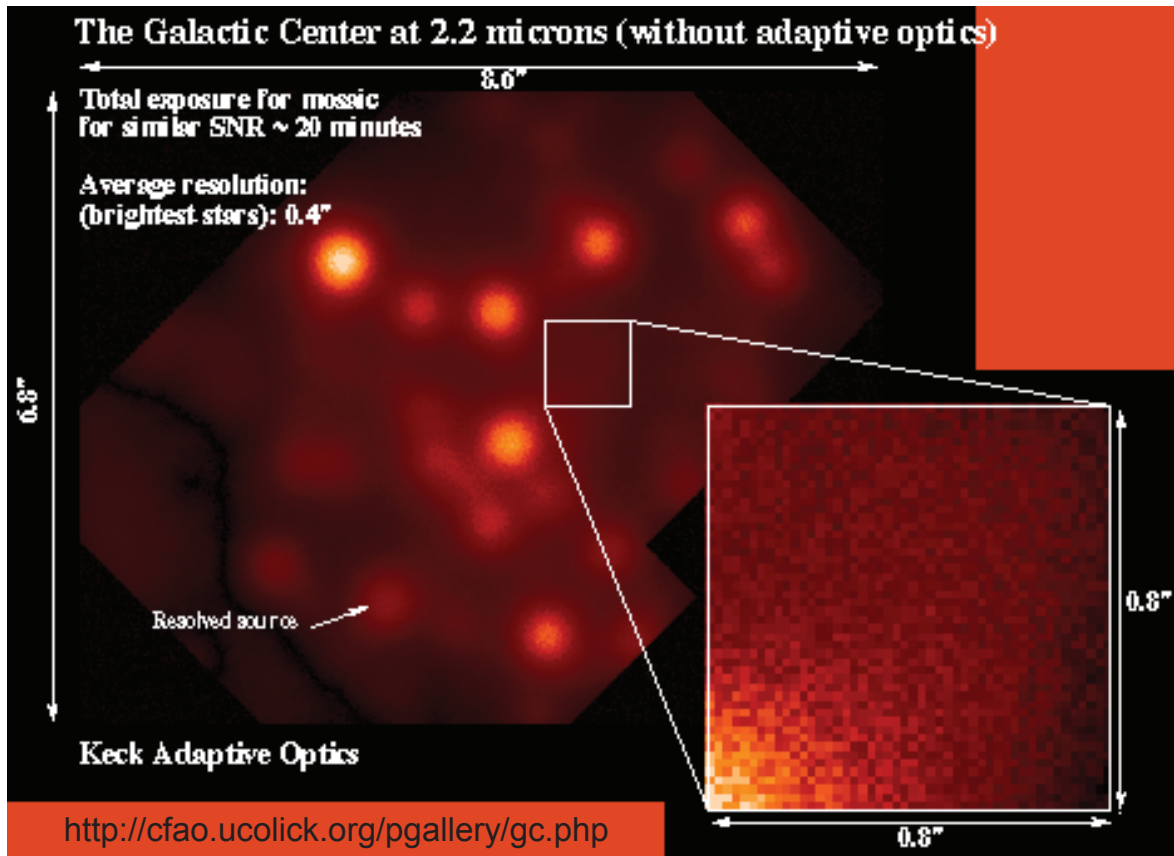

Laser Guide Stars

Sky Coverage

To sense the wavefront one *needs a bright reference/guide star* within the isoplanatic angle.

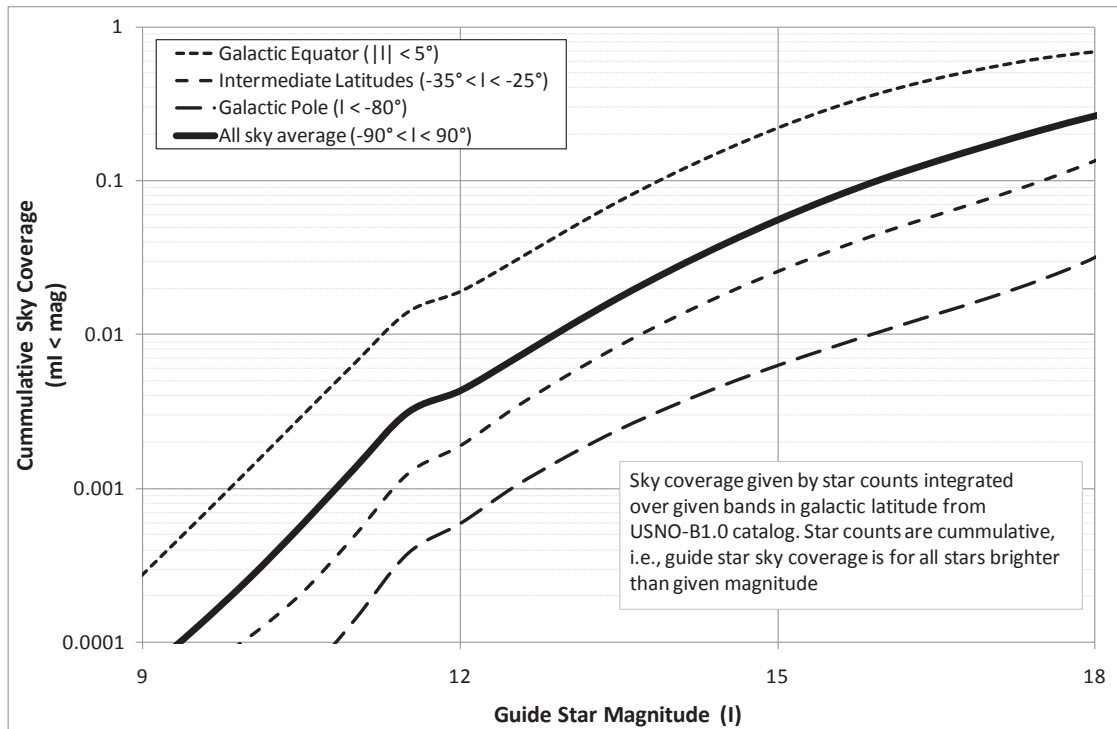

Cumulative sky coverage, i.e., the chance of finding stars brighter than given magnitude, for a random target as a function of I-band magnitude using the USNO-B1.0 catalogue.

Laser Guide Stars

Solution to the sky coverage problem:
create your own guide star.

Two principle concepts:

- **Sodium LGS** - excite atoms in "sodium layer" at altitude of ~ 95 km.
- **Rayleigh beacon LGS** - scattering from air molecules sends light back into telescope, $h \sim 10$ km

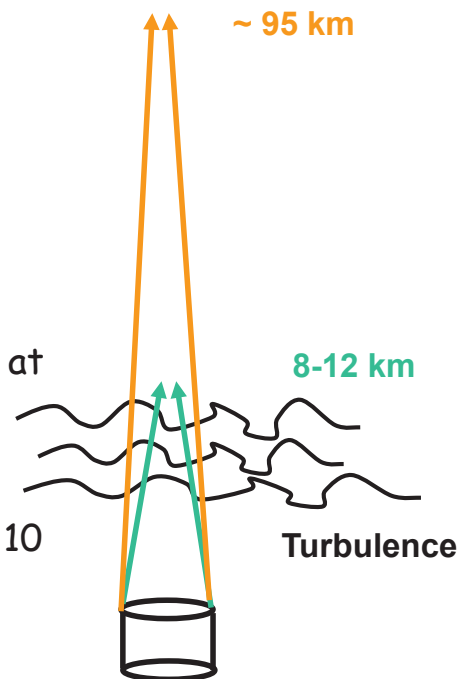

Since the beam travels twice (up and down) through the atmosphere, tip-tilt cannot be corrected \rightarrow LGS-AO *still needs a natural guide star*, but this one can be *much fainter* (~ 18 mag) as it is only needed for tip-tilt sensing.

Sodium Beacons

Layer of neutral sodium atoms in mesosphere (height ~ 95 km, thickness ~10km) thought to be deposited as smallest meteorites burn up.
Resonant scattering occurs when incident laser is tuned to D2 line of Na at 589 nm.

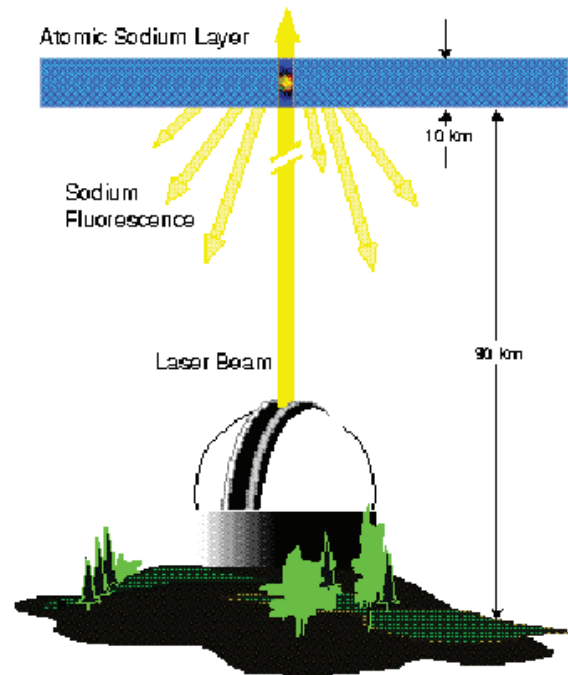

Rayleigh Beacons

Due to **interactions** of the electromagnetic wave from the laser beam with **molecules** in the atmosphere.

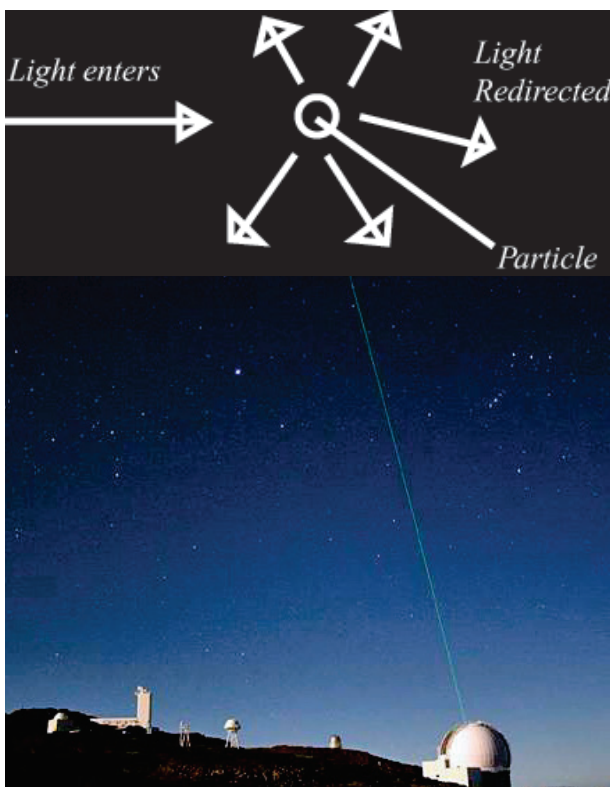

Advantages:

- cheaper and easier to build
- higher power
- independent of Na layer

Disadvantages:

- larger **focus anisoplanatism**
- laser pulses → timing

Focus Anisoplanatism

The LGS is at finite distance H above the telescope and does not sample all turbulence and not the same column of turbulent atmosphere ("cone effect"):

The contribution to the wavefront error contribution from focus

anisoplanatism is: $\sigma_{FA}^2 = \left(\frac{D}{d_0}\right)^{5/3}$

where $d_0 \sim \lambda^{6/5}$ depends only on wavelength and turbulence profile at the telescope site.

→ very large telescopes need multiple LGSs due to this cone effect.

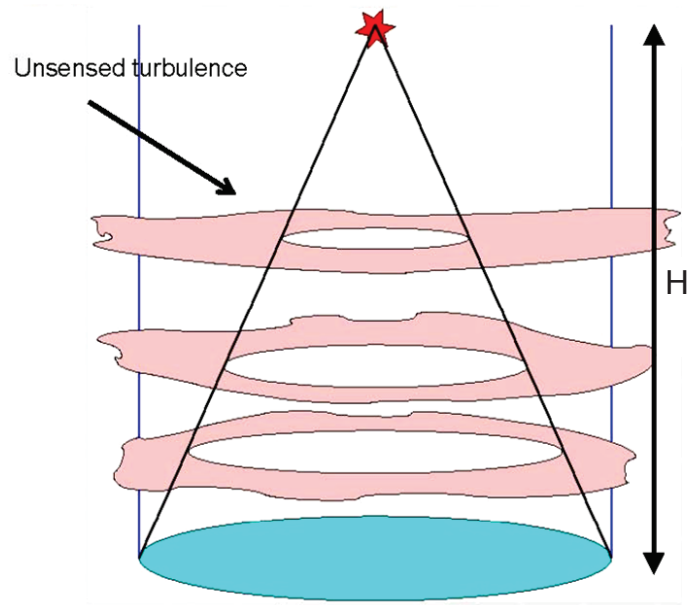

More Types of AO Concepts

Ground Layer AO - GLAO

- Useful if ground layer (= ground + dome + mirror seeing) is the dominant component
- Uses **several WFS and guide stars** within a large FOV (several arcmin).
- **WFS signals are averaged** → control **one DM**
- Reduction of FWHM ~ factor of two (only!)
- GLAO is thus a "**seeing enhancement**" technique.
- Advantage: wider fields and shorter wavelengths

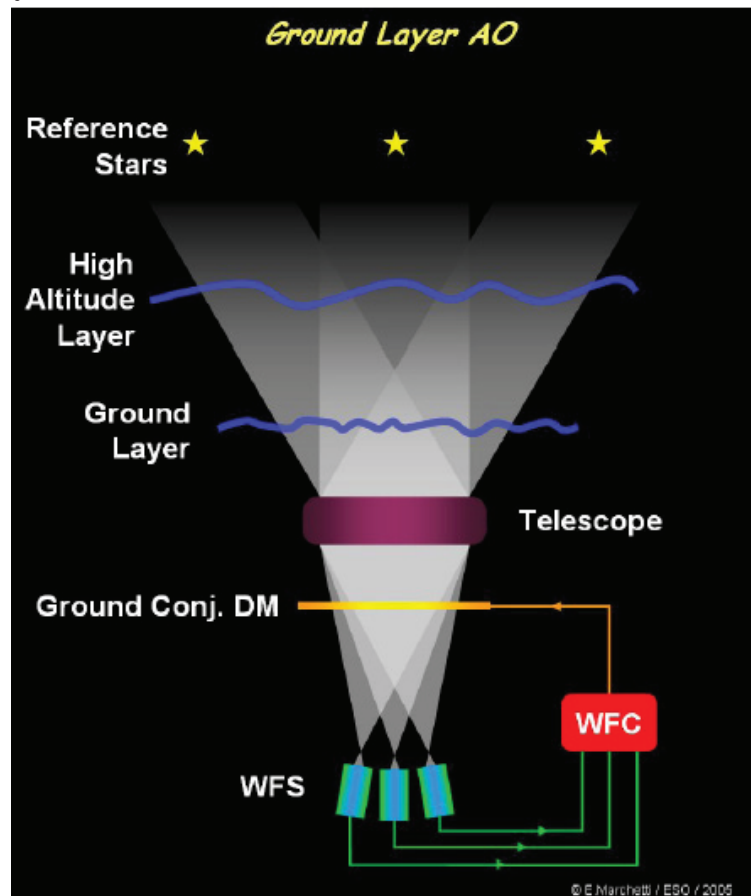

Laser Tomography AO - LTAO

- Uses **multiple laser beacons**
- **each laser has its WFS**
- combined information is used to optimize the correction by **one DM** on-axis.
- reduces the cone effect
- system performance similar to natural guide star AO but at **much higher sky coverage**.

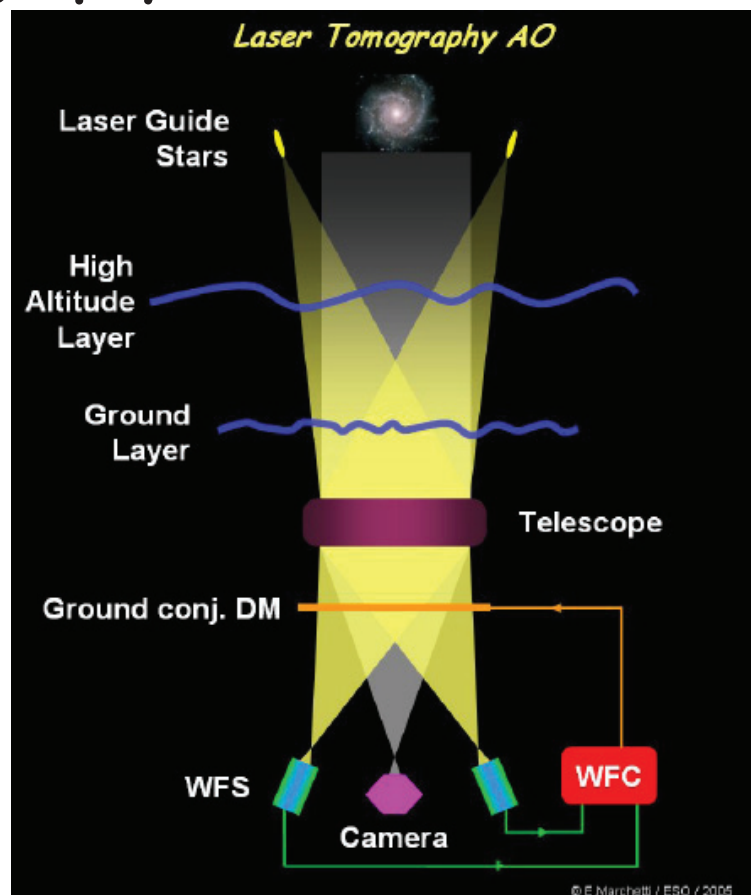

Multi-Conjugate AO - MCAO

- to overcome anisoplanatism, the basic limitation of single guide star AO.
- MCAO uses multiple NGS or LGS.
- MCAO controls several DMs
- each DM is conjugated to a different atmospheric layer at a different altitude
- at least one DM is conjugated to the ground layer
- best approach to larger corrected FOV.

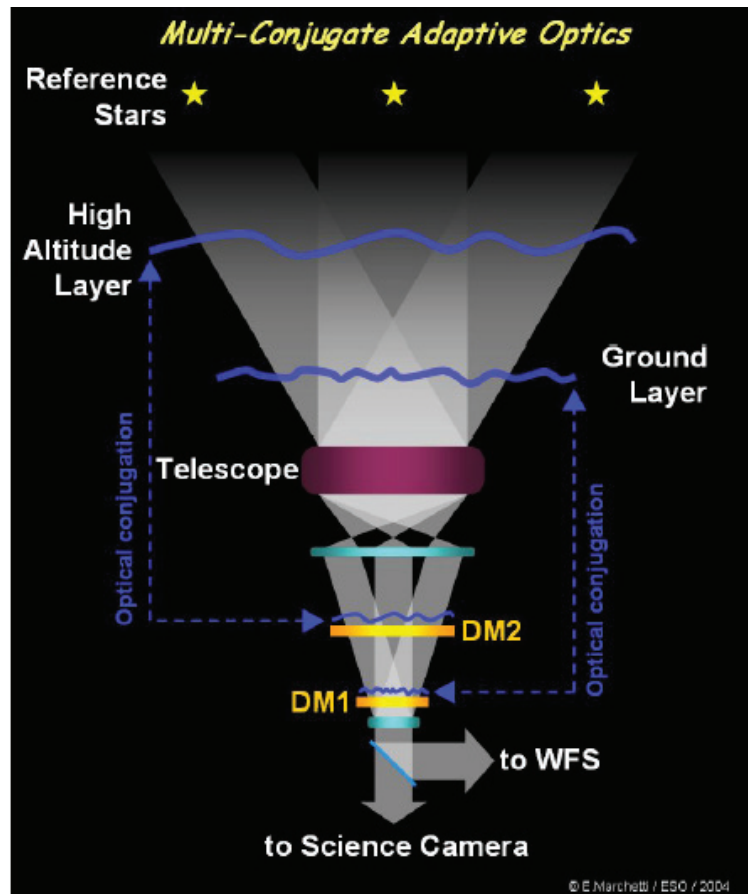

Side note: MCAO: Performance

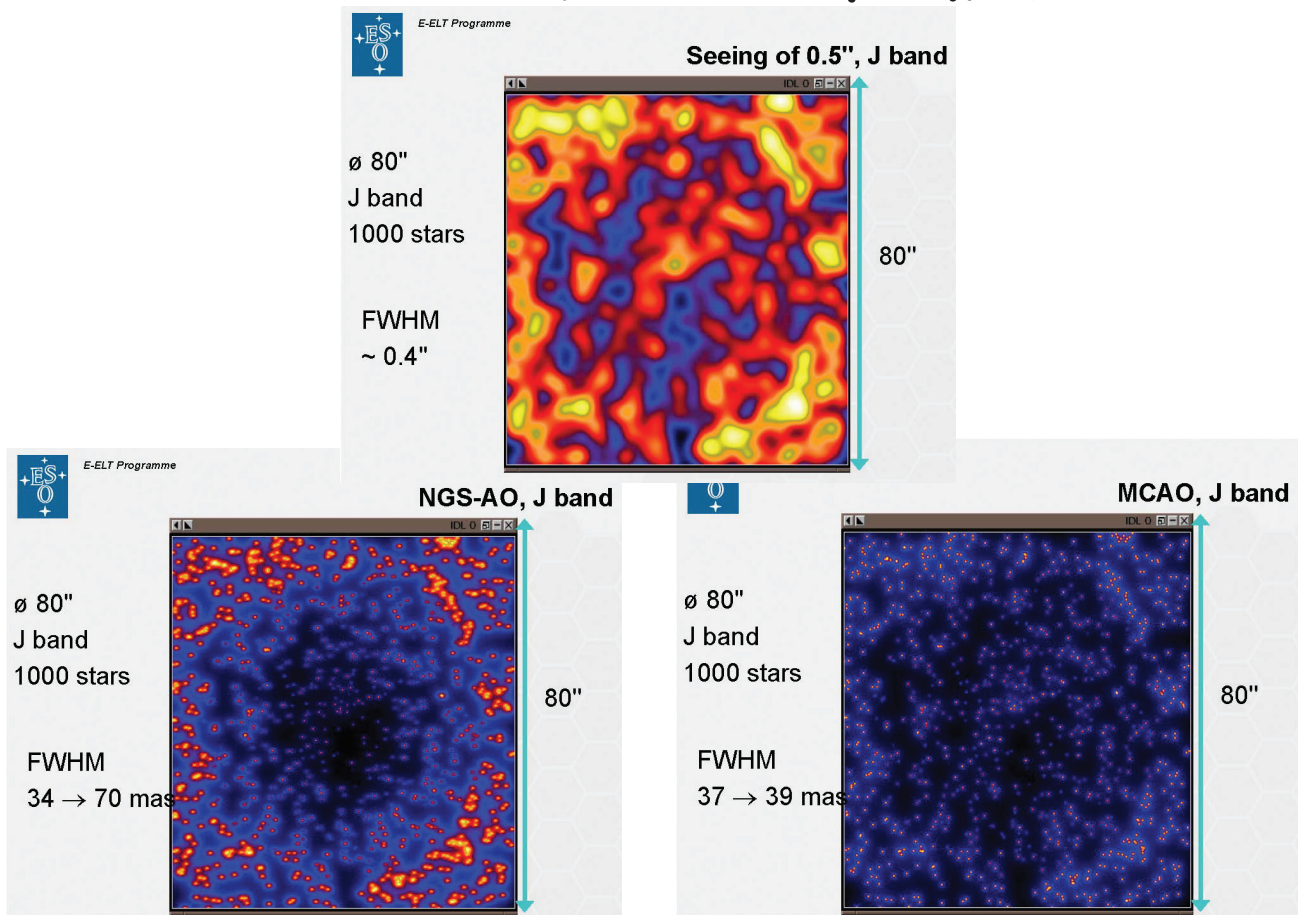

Multi-Object AO - MOAO

- MOAO provides **correction** not over the entire FOV of several arcmin but **only in local areas** within several arcmin → **multi-object spectroscopy**.
- needs (several) **guide stars** close to each science target.
- picks up the WFS light via small "arms" inserted in the FOV.
- **each science target has its DM**
- systems work in **open loop** (!)

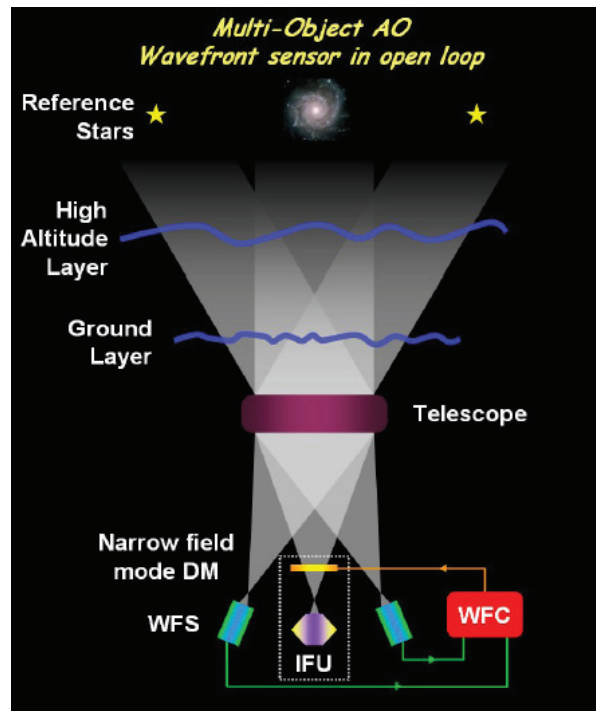
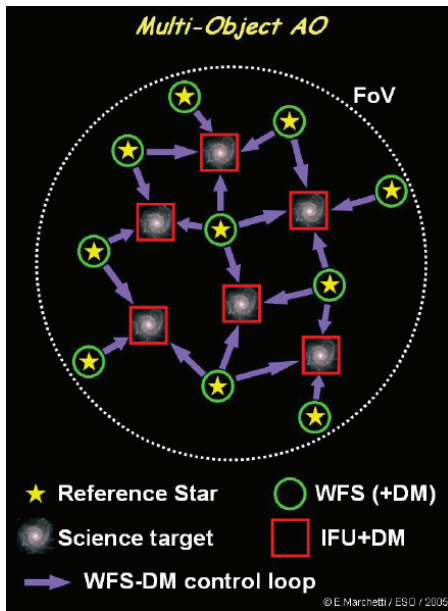

Extreme AO - XAO

- XAO is configured **similarly** than SCAO
- high Strehl **on-axis** and **small corrected FOV**
- however, Strehl values in excess of 90%
- requires **many thousands of DM actuators**
- requires to minimize optical and alignment errors
- main application: **search for exoplanets**, like with SPHERE on the VLT →

